

ESKV-L 12 LT

Cable gland LowTemp, polyamide, M12, RAL 7035 with long thread

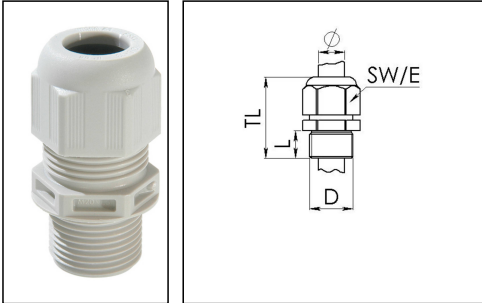

Product illustrations are exemplary and may differ from the chosen product. Further variants and individual customization, we will gladly provide you on request.



Material cable gland	Polyamide
Material sealing gasket	Silicone
Protection class	IP69, IP68 (5 bar 30 min)
Temp. range min	-60 °C
Temp. range max	100 °C
Glow wire test	750 °C
Thread type	M
Ø Connection thread D	12
Lead	1,5
Length screw-in thread L	15 mm
Ø cable diameter min	3 mm
Ø cable diameter max	7 mm
Key width SW	16 mm
Collar diameter (E)	18 mm
Total length TL	35 mm - 40 mm
Type of cable anchorage	A
Install. torques fitting	2 N m
Install. torques cap nut	2 N m
Impact category	2
Product Color	RAL 7035
Type	ESKV-L 12 LT
Order no. RAL 7035	10062737
Packing unit	50
ETIM-Classification	EC000441

Your Contact:

WISKA Electric Systems (Shanghai) Co., Ltd

Mr. Xu Deqin · Room 502, Building 3, No.400 Fangchun Road · Pudong Zhangjiang High-Tech Industry Park · Shanghai, China

☎ +86 21 58440056 · 📠 +86 21 58440031

xudeqin@wiska.cn · www.wiska.cn

Recommended accessories

RDE 12 LT	10063981
BS 7	10064005
EADR 12/90 LT	10105704

21.07.2018

Your Contact:

WISKA Electric Systems (Shanghai) Co., Ltd

Mr. Xu Deqin · Room 502, Building 3, No.400 Fangchun Road · Pudong Zhangjiang High-Tech Industry Park · Shanghai, China

☎ +86 21 58440056 · 📠 +86 21 58440031

xudeqin@wiska.cn · www.wiska.cn



Your Contact:

WISKA Electric Systems (Shanghai) Co., Ltd

Mr. Xu Deqin · Room 502, Building 3, No.400 Fangchun Road · Pudong Zhangjiang High-Tech Industry Park · Shanghai, China

☎ +86 21 58440056 · 📠 +86 21 58440031

xudeqin@wiska.cn · www.wiska.cn