

NMSKE 1/2 EMV-S

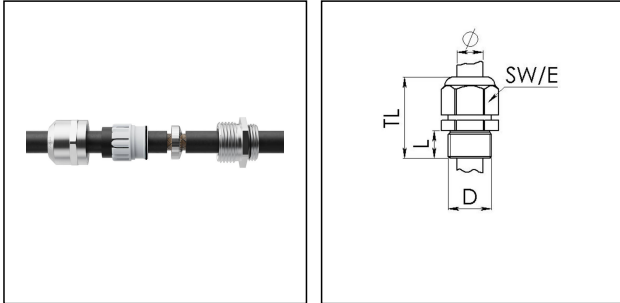

Products may differ in size, colour and appearance to those shown. If you require further information or customisation, please contact us directly.



Material cable gland	Brass nickel-plated
Material clamping cage	Polyamide
Material sealing gasket	EPDM
Material earthing insert	Stainless steel 1.4310
Temp. range min	-40 °C
Temp. range max	75 °C
Protection class	IP66 / IP68 (5 bar 30 min)
Type of protection	Ex tb, Ex eb
Ex-Certificate	IECEx, ATEX
Thread type	NPT
Ø Connection thread D	1/2"
Length screw-in thread L	16 mm
Ø cable diameter min	6 mm
Ø cable diameter max	13 mm
Ø cable below cable shield max	9,5 mm
Key width SW	24 mm
Collar diameter (E)	27 mm
Total length TL	38 mm - 45 mm
Install. torques fitting	8 N m
Install. torques cap nut	8 N m
Surface	Nickel-plated
Order no. nickel-plated	10113950
Type	NMSKE 1/2 EMV-S
Packing unit	50
Tariff number	85369010

Your Contact:

WISKA Electric Systems (Shanghai) Co., Ltd · 维司卡电气设备(上海)有限公司

Room 703, Building 4, No. 258 Jinzang Road, Pudong Jinqiao Export Processing Zone, Shanghai, P.R.China 201206

上海市浦东新区金桥出口加工区金藏路258号4号楼703室 201206

☎ +86-21-58440056 · ☎ +86-21-58440027 · 📠 +86-21-58440031 · contact@wiska.cn · www.wiska.cn

EAN number	4007686324419
ETIM-Classification	EC000441

Recommended accessories

RDE 20	10062185
BS 13	10064010

11.05.2026

Your Contact:

WISKA Electric Systems (Shanghai) Co., Ltd · 维司卡电气设备(上海)有限公司

Room 703, Building 4, No. 258 Jinzang Road, Pudong Jinqiao Export Processing Zone, Shanghai, P.R.China 201206

上海市浦东新区金桥出口加工区金藏路258号4号楼703室 201206

☎ +86-21-58440056 · ☎ +86-21-58440027 · 📠 +86-21-58440031 · contact@wiska.cn · www.wiska.cn



Your Contact:

WISKA Electric Systems (Shanghai) Co., Ltd · 维司卡电气设备(上海)有限公司

Room 703, Building 4, No. 258 Jinzang Road, Pudong Jinqiao Export Processing Zone, Shanghai, P.R.China 201206

上海市浦东新区金桥出口加工区金藏路258号4号楼703室 201206

☎ +86-21-58440056 · ☎ +86-21-58440027 · 📠 +86-21-58440031 · contact@wiska.cn · www.wiska.cn