

NMSKE 1 1/2 EMV-S

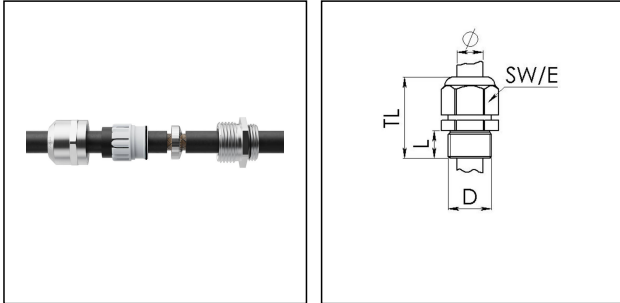

Products may differ in size, colour and appearance to those shown. If you require further information or customisation, please contact us directly.



Material cable gland	Brass nickel-plated
Material clamping cage	Polyamide
Material sealing gasket	EPDM
Material earthing insert	Stainless steel 1.4310
Temp. range min	-40 °C
Temp. range max	75 °C
Protection class	IP66 / IP68 (5 bar 30 min)
Type of protection	Ex tb, Ex eb
Ex-Certificate	IECEx, ATEX
Thread type	NPT
Ø Connection thread D	1 1/2"
Length screw-in thread L	20 mm
Ø cable diameter min	21 mm
Ø cable diameter max	35 mm
Ø cable below cable shield max	33 mm
Key width SW	55 mm
Collar diameter (E)	61 mm
Total length TL	51 mm - 62 mm
Install. torques fitting	30 N m
Install. torques cap nut	30 N m
Surface	Nickel-plated
Order no. nickel-plated	10113954
Type	NMSKE 1 1/2 EMV-S
Packing unit	10
Tariff number	85369010

Your Contact:

WISKA Electric Systems (Shanghai) Co., Ltd · 维司卡电气设备(上海)有限公司

Room 703, Building 4, No. 258 Jinzang Road, Pudong Jinqiao Export Processing Zone, Shanghai, P.R.China 201206

上海市浦东新区金桥出口加工区金藏路258号4号楼703室 201206

☎ +86-21-58440056 · ☎ +86-21-58440027 · 📠 +86-21-58440031 · contact@wiska.cn · www.wiska.cn

EAN number	4007686324495
ETIM-Classification	EC000441

Recommended accessories

RDE 50	10062188
BS 35	10064017

11.05.2026

Your Contact:

WISKA Electric Systems (Shanghai) Co., Ltd · 维司卡电气设备(上海)有限公司
Room 703, Building 4, No. 258 Jinzang Road, Pudong Jinqiao Export Processing Zone, Shanghai, P.R.China 201206
上海市浦东新区金桥出口加工区金藏路258号4号楼703室 201206
☎ +86-21-58440056 · ☎ +86-21-58440027 · 📠 +86-21-58440031 · contact@wiska.cn · www.wiska.cn



Your Contact:

WISKA Electric Systems (Shanghai) Co., Ltd · 维司卡电气设备(上海)有限公司

Room 703, Building 4, No. 258 Jinzang Road, Pudong Jinqiao Export Processing Zone, Shanghai, P.R.China 201206

上海市浦东新区金桥出口加工区金藏路258号4号楼703室 201206

☎ +86-21-58440056 · ☎ +86-21-58440027 · 📠 +86-21-58440031 · contact@wiska.cn · www.wiska.cn