

NMSKE 2 EMV-S

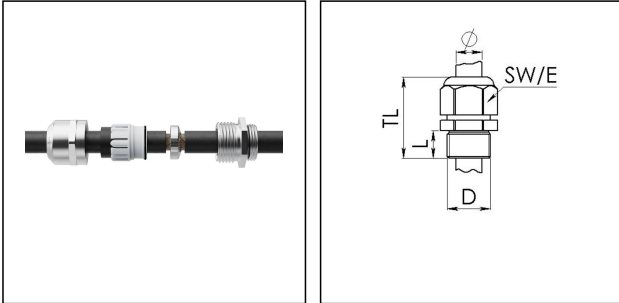

Products may differ in size, colour and appearance to those shown. If you require further information or customisation, please contact us directly.



Material cable gland	Brass nickel-plated
Material clamping cage	Polyamide
Material sealing gasket	EPDM
Material earthing insert	Stainless steel 1.4310
Temp. range min	-40 °C
Temp. range max	75 °C
Protection class	IP66 / IP68 (5 bar 30 min)
Type of protection	Ex tb, Ex eb
Ex-Certificate	IECEx, ATEX
Thread type	NPT
Ø Connection thread D	2"
Length screw-in thread L	21 mm
Ø cable diameter min	34 mm
Ø cable diameter max	48 mm
Ø cable below cable shield max	45 mm
Key width SW	68 mm
Collar diameter (E)	75 mm
Total length TL	56 mm - 67 mm
Install. torques fitting	40 N m
Install. torques cap nut	40 N m
Surface	Nickel-plated
Order no. nickel-plated	10113955
Type	NMSKE 2 EMV-S
Packing unit	10
Tariff number	85369010

Your Contact:

WISKA Electric Systems (Shanghai) Co., Ltd · 维司卡电气设备(上海)有限公司

Room 703, Building 4, No. 258 Jinzang Road, Pudong Jinqiao Export Processing Zone, Shanghai, P.R.China 201206

上海市浦东新区金桥出口加工区金藏路258号4号楼703室 201206

☎ +86-21-58440056 · ☎ +86-21-58440027 · 📠 +86-21-58440031 · contact@wiska.cn · www.wiska.cn

EAN number	4007686324518
ETIM-Classification	EC000441

Recommended accessories

RDE 63	10062189
BS 48	10064019

11.05.2026

Your Contact:

WISKA Electric Systems (Shanghai) Co., Ltd · 维司卡电气设备(上海)有限公司
Room 703, Building 4, No. 258 Jinzang Road, Pudong Jinqiao Export Processing Zone, Shanghai, P.R.China 201206
上海市浦东新区金桥出口加工区金藏路258号4号楼703室 201206
☎ +86-21-58440056 · ☎ +86-21-58440027 · 📠 +86-21-58440031 · contact@wiska.cn · www.wiska.cn



Your Contact:

WISKA Electric Systems (Shanghai) Co., Ltd · 维司卡电气设备(上海)有限公司

Room 703, Building 4, No. 258 Jinzang Road, Pudong Jinqiao Export Processing Zone, Shanghai, P.R.China 201206

上海市浦东新区金桥出口加工区金藏路258号4号楼703室 201206

☎ +86-21-58440056 · ☎ +86-21-58440027 · 📠 +86-21-58440031 · contact@wiska.cn · www.wiska.cn